



CX Lighting



专业制造平板灯

Professional manufacturing LED panel light

安徽臣昕照明电器有限公司

Anhui Chenxin Lighting Electrical Appliance Co.,LTD

目录 CATALOGUE



新款三条平板灯 格栅款
Anti-glare three glow backlight panel

P-01



新款三条平板灯 明装款
Surface three glow backlight panel

P-02



6060新款无边框直发光
Borderless backlight panel

P-04



集成款直发光平板灯
Integrated backlight panel

P-05



美规直发光平板灯
American standard backlight panel

P-07



集成款侧发光平板灯
Integrated side light panel

P-08



吊装平板灯
Hoisting flat lamp

P-10

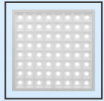

超薄64格圆形平板灯
Ultra-thin 64 grid round flat lamp

P-11

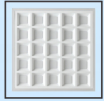

25格方形平板灯
25 Grid square flat lamp

P-13



格栅灯-月牙 梅花
Grille panel

P-14

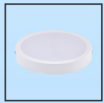

DOB面板灯
DOB panel lamp

P-16



壁灯
Wall light

P-18



新款三条平板灯 二合一款
Anti-glare three glow backlight panel-PC &UGR

P-01



新款二条平板灯 格栅款
Anti-glare two glow backlight panel

P-03



30120新款无边框直发光
Borderless backlight panel

P-04



明装直发光平板灯
Surface backlight panel

P-06

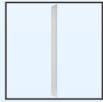

非标直发光平板灯
Non-standard backlight panel

P-07



明装方形侧发光平板灯
Surface mounted square side light panel

P-09



防水侧发光平板灯
Waterproof side light panel

P-10

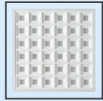

36格方形防眩光平板灯
36 Grid square anti-glare flat lamp

P-12

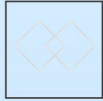

边框灯
Frame panel

P-13



底发光小面板灯
Backlight small panel lamp

P-15



侧发光面板灯
Side light panel lamp

P-16



轨道磁吸灯
Track magnetic absorption lamp

P-19



新款三条平板灯 泛光款
Three glow backlight panel-PC

P-02



新款32格平板灯
32 Grid square anti-glare backlight panel

P-03



工程款直发光平板灯
Engineering fund backlight panel

P-05



防水直发光平板灯
Waterproof backlight panel

P-06



工程款侧发光平板灯
Engineering fund side light panel

P-08



明装圆形侧发光平板灯
Surface mounted round side light panel

P-09



侧发光净化灯
Side light panel Purifying lamp

P-11

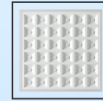

36格圆形平板灯
36 Grid round flat lamp

P-12



四格格栅灯
Four grille panel

P-14

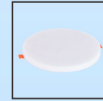

无边框面板灯
Borderless panel lamp

P-15

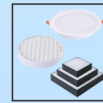

蜂窝面板灯
超窄边 内斜筒灯
Honey panel lamp/Ultra-narrow lamp/Interior inclined downlight

P-17

平板灯配件
Panel accessories

P-20

新款三条平板灯 格栅款
Anti-glare three glow backlight panel



型号 (Model)	TG-UGR-595
尺寸 (Size)	595*595
功率 (Power)	40W 48W 60W 72W
电源类型 (Type of power supply)	No-isolated Isolated Certified
灯珠型号 (Chip model)	2835 3V/9V
发光角度 (Luminous angle)	120°
LED功耗/光通量 (LED power consumption/luminous flux)	100LM/W
防眩值 (Anti glare value)	UGR<16

新款三条平板灯 二合一款
Anti-glare three glow backlight panel-PC &UGR



型号 (Model)	TG-PC&UGR-595
尺寸 (Size)	595*595
功率 (Power)	40W 48W 60W 72W
电源类型 (Type of power supply)	No-isolated Isolated Certified
灯珠型号 (Chip model)	2835 3V/9V
发光角度 (Luminous angle)	120°
LED功耗/光通量 (LED power consumption/luminous flux)	100LM/W
防眩值 (Anti glare value)	UGR<16

新款三条平板灯 泛光款

Three glow backlight panel-PC

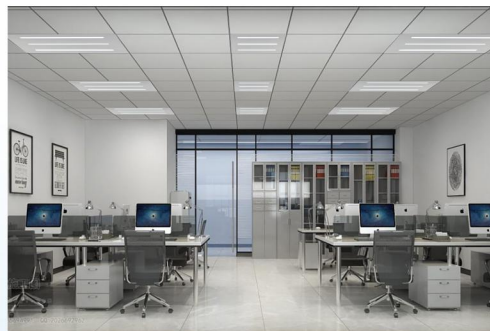

型号 (Model)	TG-PC-595
尺寸 (Size)	595*595
功率 (Power)	40W 48W 60W 72W
电源类型 (Type of power supply)	No-isolated Isolated Certified
灯珠型号 (Chip model)	2835 3V/9V
发光角度 (Luminous angle)	120°
LED功耗/光通量 (LED power consumption/luminous flux)	100LM/W
防眩值 (Anti glare value)	UGR<19

新款三条平板灯 明装款

Surface three glow backlight panel



型号 (Model)	TG-SUR-6060
尺寸 (Size)	600*600
功率 (Power)	40W 48W 60W 72W
电源类型 (Type of power supply)	No-isolated Isolated Certified
灯珠型号 (Chip model)	2835 3V/9V
发光角度 (Luminous angle)	120°
LED功耗/光通量 (LED power consumption/luminous flux)	100LM/W
防眩值 (Anti glare value)	UGR<16

新款二条平板灯 格栅款

Anti-glare two glow backlight panel



型号 (Model)	TG-UGR-30120
尺寸 (Size)	300*1200
功率 (Power)	40W 48W 60W 72W
电源类型 (Type of power supply)	No-isolated Isolated Certified
灯珠型号 (Chip model)	2835 3V/9V
发光角度 (Luminous angle)	120°
LED功耗/光通量 (LED power consumption/luminous flux)	100LM/W
防眩值 (Anti glare value)	UGR<16

新款32格平板灯

32 Grid square anti-glare backlight panel

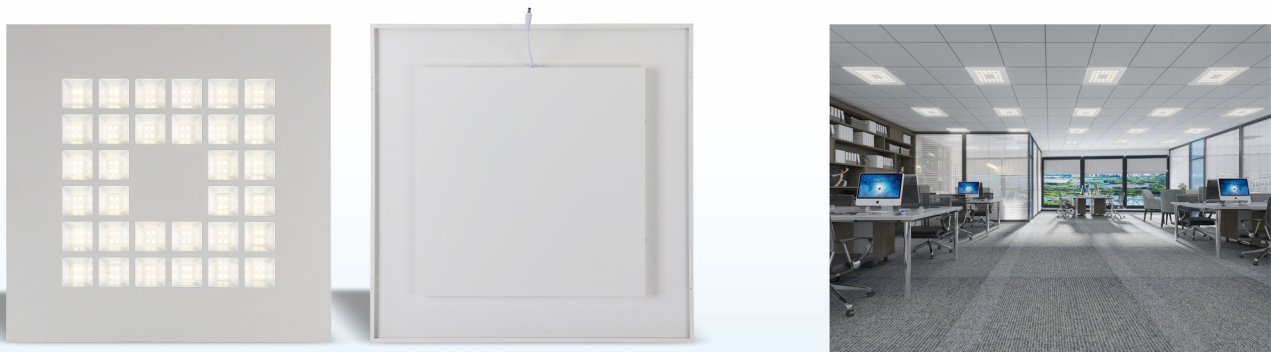

型号 (Model)	UGR-S32
尺寸 (Size)	595*595
功率 (Power)	40W 48W 60W 72W
电源类型 (Type of power supply)	No-isolated Isolated Certified
灯珠型号 (Chip model)	2835 9V 1.5W
发光角度 (Luminous angle)	120°
LED功耗/光通量 (LED power consumption/luminous flux)	100LM/W
防眩值 (Anti glare value)	UGR<16

6060新款无边框直发光 Borderless backlight panel

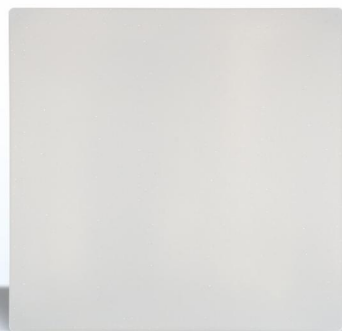

型号 (Model)	BL-SUR-6060
尺寸 (Size)	600*600
功率 (Power)	40W 48W 60W
电源类型 (Type of power supply)	No-isolated Certificated
灯珠型号 (Chip model)	2835 9V 1.5W
发光角度 (Luminous angle)	120°
LED功耗/光通量 (LED power consumption/luminous flux)	100LM/W

30120新款无边框直发光 Borderless backlight panel

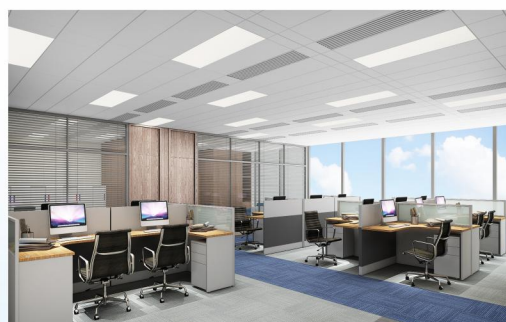
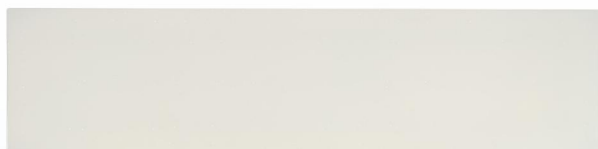

型号 (Model)	BL-SUR-30120
尺寸 (Size)	300*1200
功率 (Power)	40W 48W 60W
电源类型 (Type of power supply)	No-isolated Certificated
灯珠型号 (Chip model)	2835 9V 1.5W
发光角度 (Luminous angle)	120°
LED功耗/光通量 (LED power consumption/luminous flux)	100LM/W

工程款直发光平板灯 Engineering fund backlight panel

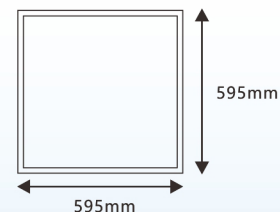

型号 (Model)	BK-GC-595
尺寸 (Size)	595*595
功率 (Power)	36W 48W 60W 72W 96W
电源类型 (Type of power supply)	No-isolated Isolated Certificated
灯珠型号 (Chip model)	2835 9V 1.5W
发光角度 (Luminous angle)	120°
LED功耗/光通量 (LED power consumption/luminous flux)	100LM/W

集成款直发光平板灯 Integrated backlight panel

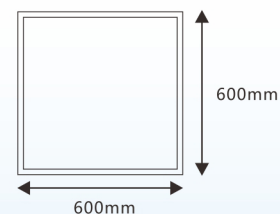

型号 (Model)	BK-JC-595
尺寸 (Size)	600*600
功率 (Power)	36W 48W 60W 72W 96W
电源类型 (Type of power supply)	No-isolated Isolated Certificated
灯珠型号 (Chip model)	2835 9V 1.5W
发光角度 (Luminous angle)	120°
LED功耗/光通量 (LED power consumption/luminous flux)	100LM/W

明装直发光平板灯 Surface backlight panel

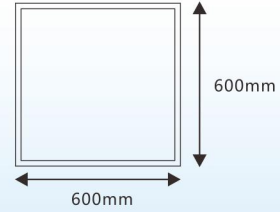

型号 (Model)	BK-SUR-6060
尺寸 (Size)	600*600
功率 (Power)	36W 48W 60W
电源类型 (Type of power supply)	No-isolated Isolated Certificated
灯珠型号 (Chip model)	2835 9V 1.5W
发光角度 (Luminous angle)	120°
LED功耗/光通量 (LED power consumption/luminous flux)	100LM/W

防水直发光平板灯 Waterproof backlight panel

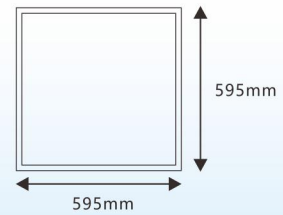
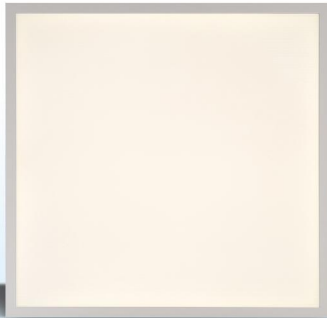

型号 (Model)	BK-IP65-595
尺寸 (Size)	595*595
功率 (Power)	36W 40W 48W 60W 72W
电源类型 (Type of power supply)	No-isolated Isolated Certificated
灯珠型号 (Chip model)	2835 9V 1.5W
发光角度 (Luminous angle)	120°
LED功耗/光通量 (LED power consumption/luminous flux)	100LM/W

美规直发光平板灯 American standard backlight panel

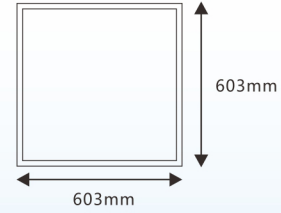

型号 (Model)	BK-ETL-603
尺寸 (Size)	603*603
功率 (Power)	40W 50W
电源类型 (Type of power supply)	No-isolated Isolated Certificated
灯珠型号 (Chip model)	2835 9V 1.5W
发光角度 (Luminous angle)	120°
LED功耗/光通量 (LED power consumption/luminous flux)	100LM/W

非标直发光平板灯 Non-standard backlight panel



型号 (Model)	BK-NS-10120/15120
尺寸 (Size)	100*1200/150*1200
功率 (Power)	24W
电源类型 (Type of power supply)	No-isolated Isolated Certificated
灯珠型号 (Chip model)	2835 9V 1.5W
发光角度 (Luminous angle)	120°
LED功耗/光通量 (LED power consumption/luminous flux)	100LM/W

工程款侧发光平板灯 Engineering fund side light panel

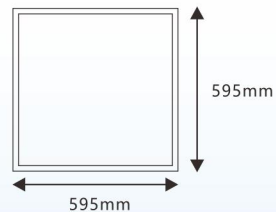
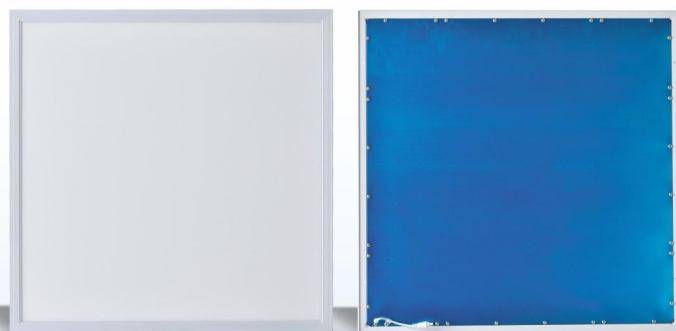

型号 (Model)	SL-GC-595
尺寸 (Size)	595*595
功率 (Power)	36W 40W 48W 60W 72W
电源类型 (Type of power supply)	No-isolated Isolated Certificated
灯珠型号 (Chip model)	4014 3V 0.5W
发光角度 (Luminous angle)	120°
LED功耗/光通量 (LED power consumption/luminous flux)	100LM/W

集成款侧发光平板灯 Integrated side light panel

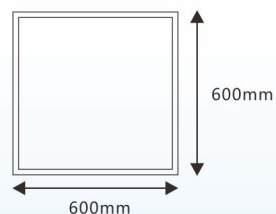

型号 (Model)	SL-JC-595
尺寸 (Size)	600*600
功率 (Power)	36W 40W 48W 60W 72W
电源类型 (Type of power supply)	No-isolated Isolated Certificated
灯珠型号 (Chip model)	4014 3V 0.5W
发光角度 (Luminous angle)	120°
LED功耗/光通量 (LED power consumption/luminous flux)	100LM/W

明装方形侧发光平板灯

Surface mounted square side light panel

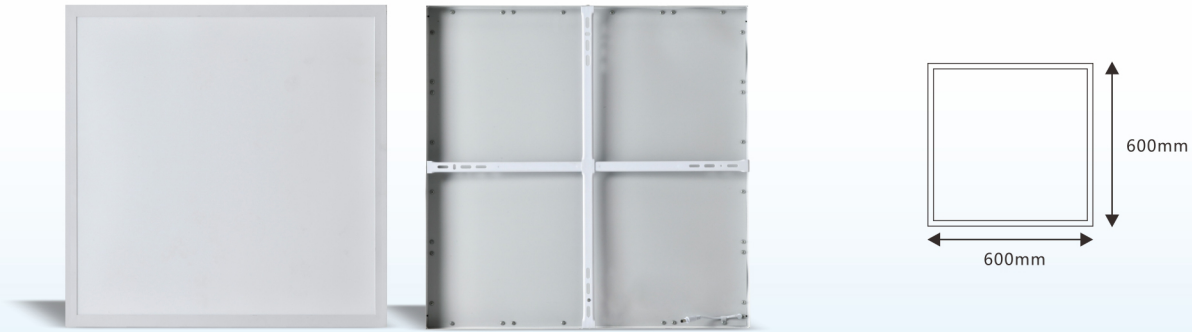

型号 (Model)	SL-SUR-S6060
尺寸 (Size)	600*600
功率 (Power)	36W 40W 48W 60W
电源类型 (Type of power supply)	ETL Certified
灯珠型号 (Chip model)	4014 3V 0.5W
发光角度 (Luminous angle)	120°
LED功耗/光通量 (LED power consumption/luminous flux)	100LM/W

明装圆形侧发光平板灯

Surface mounted round side light panel



型号 (Model)	SL-SUR-R600
尺寸 (Size)	600*600
功率 (Power)	36W 40W 48W
电源类型 (Type of power supply)	No-isolated Isolated Certified
灯珠型号 (Chip model)	2835 3V 0.5W
发光角度 (Luminous angle)	120°
LED功耗/光通量 (LED power consumption/luminous flux)	100LM/W

吊装平板灯 Hoisting flat lamp

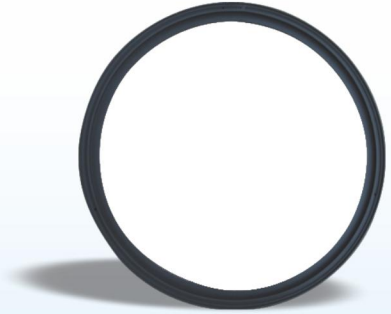

型号 (Model)	SL-R-600
尺寸 (Size)	Φ300mm-Φ1000mm
功率 (Power)	36W 40W 48W 60W
电源类型 (Type of power supply)	No-isolated Isolated Certificated
灯珠型号 (Chip model)	2835 3V 0.5W
发光角度 (Luminous angle)	120°
LED功耗/光通量 (LED power consumption/luminous flux)	100LM/W

防水侧发光平板灯 Waterproof side light panel

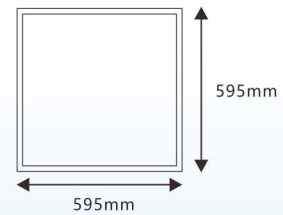
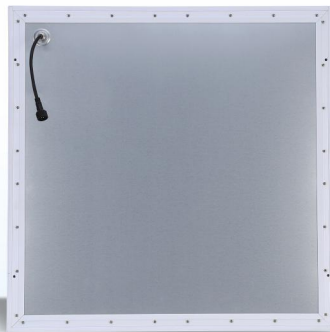

型号 (Model)	SL-IP65-595
尺寸 (Size)	595*595
功率 (Power)	36W 40W 50W
电源类型 (Type of power supply)	No-isolated Isolated Certificated
灯珠型号 (Chip model)	2835 3V 0.5W
发光角度 (Luminous angle)	120°
LED功耗/光通量 (LED power consumption/luminous flux)	100LM/W

侧发光净化灯 Side light panel Purifying lamp

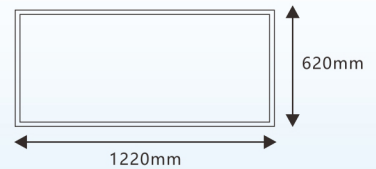
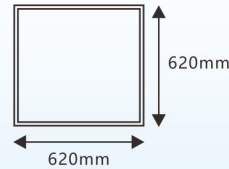
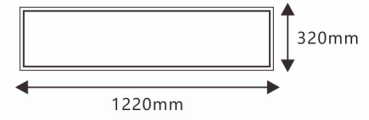
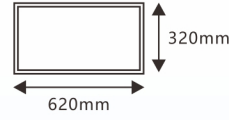
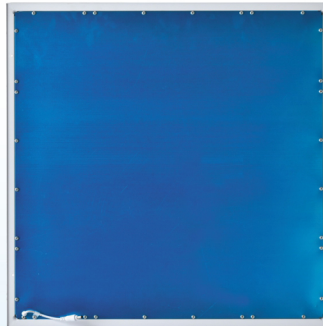

型号 (Model)	SL-P-620
尺寸 (Size)	320*620/320*1220/620*620/620*1220
功率 (Power)	36W 40W 48W 60W 72W
电源类型 (Type of power supply)	No-isolated Isolated Certificated
灯珠型号 (Chip model)	4014 3V 0.5W
发光角度 (Luminous angle)	120°
LED功耗/光通量 (LED power consumption/luminous flux)	100LM/W

超薄64格圆形平板灯 Ultra- thin 64 grid round flat lamp

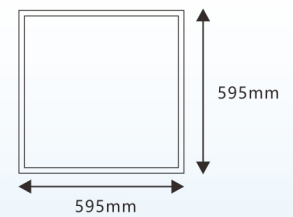
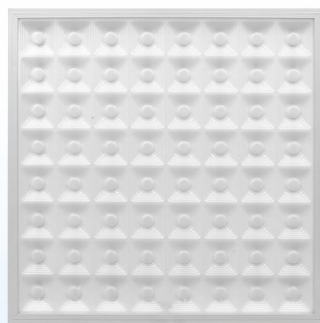
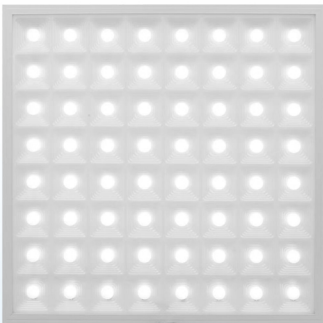

型号 (Model)	GR-R64
尺寸 (Size)	595*595
功率 (Power)	48W 60W 72W 96W 120W
电源类型 (Type of power supply)	No-isolated Isolated Certificated
灯珠型号 (Chip model)	2835 9V
发光角度 (Luminous angle)	120°
LED功耗/光通量 (LED power consumption/luminous flux)	100LM/W

36格方形防眩光平板灯 36 Grid square anti-glare flat lamp

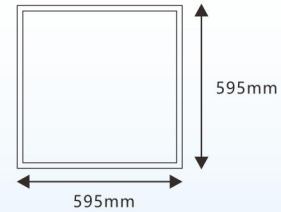
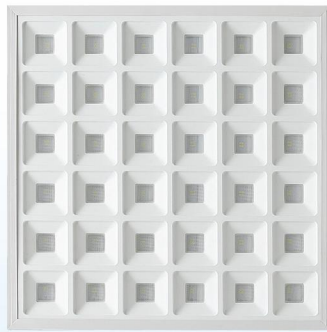

型号 (Model)	GR-UGR-S36
尺寸 (Size)	595*595
功率 (Power)	48W 60W 72W 96W
电源类型 (Type of power supply)	No-isolated Isolated Certificated
灯珠型号 (Chip model)	2835 3V/6V
发光角度 (Luminous angle)	120°
LED功耗/光通量 (LED power consumption/luminous flux)	100LM/W
防眩值 (Anti glare value)	UGR<19

36格圆形平板灯 36 Grid round flat lamp

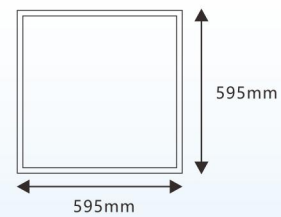
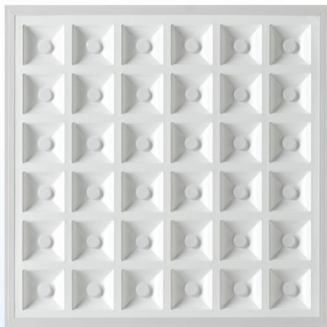

型号 (Model)	GR-R36
尺寸 (Size)	595*595
功率 (Power)	48W 60W 72W 96W
电源类型 (Type of power supply)	No-isolated Isolated Certificated
灯珠型号 (Chip model)	2835 3V/6V
发光角度 (Luminous angle)	120°
LED功耗/光通量 (LED power consumption/luminous flux)	100LM/W

25格方形平板灯 25 Grid square flat lamp

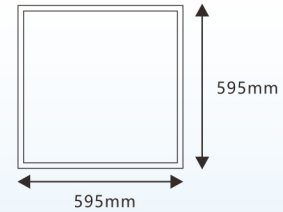
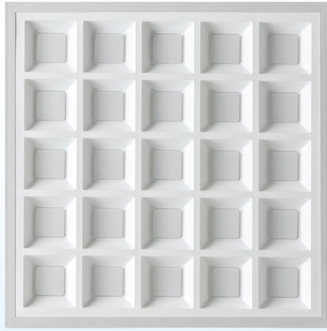

型号 (Model)	GR-S25
尺寸 (Size)	595*595
功率 (Power)	60W 96W 120W
电源类型 (Type of power supply)	No-isolated Isolated Certified
灯珠型号 (Chip model)	2835 3V/6V
发光角度 (Luminous angle)	120°
LED功耗/光通量 (LED power consumption/luminous flux)	100LM/W

边框灯 Frame panel

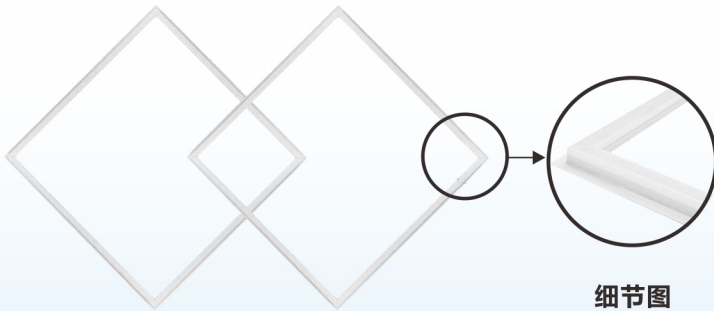

细节图

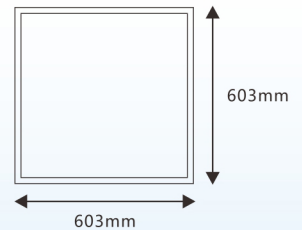
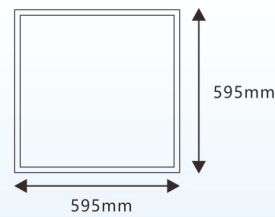

型号 (Model)	FR-6060
尺寸 (Size)	595*595/603*603
功率 (Power)	36W 40W 48W 60W
电源类型 (Type of power supply)	No-isolated Isolated Certified
灯珠型号 (Chip model)	2835 3V 0.5W
发光角度 (Luminous angle)	120°
LED功耗/光通量 (LED power consumption/luminous flux)	100LM/W

四格格栅灯
Four grille panel

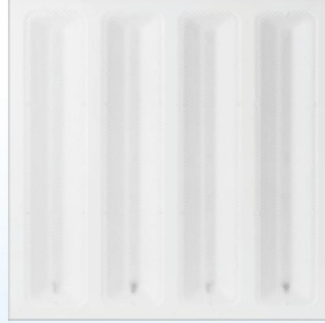
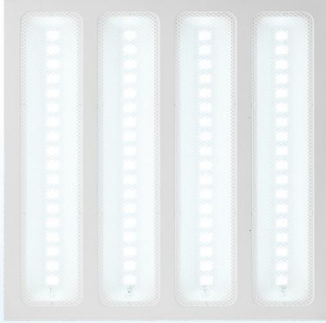

型号 (Model)	G4-595
尺寸 (Size)	595*595
功率 (Power)	48W 96W 120W
电源类型 (Type of power supply)	No-isolated
灯珠型号 (Chip model)	2835 3V/6V
发光角度 (Luminous angle)	120°
LED功耗/光通量 (LED power consumption/luminous flux)	100LM/W

格栅灯-月牙 梅花
Grille panel

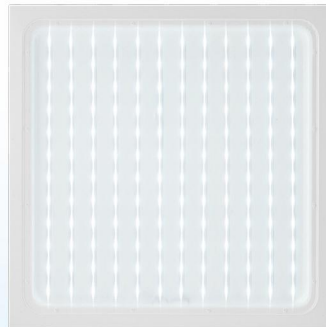
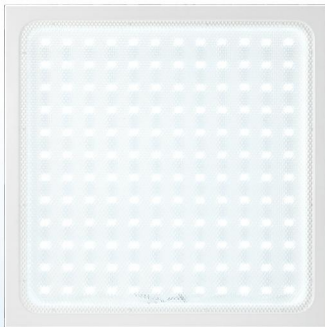

型号 (Model)	GM-595/GP-595
尺寸 (Size)	595*595
功率 (Power)	96W 120W
电源类型 (Type of power supply)	No-isolated
灯珠型号 (Chip model)	2835 6V
发光角度 (Luminous angle)	120°
LED功耗/光通量 (LED power consumption/luminous flux)	100LM/W

底发光小面板灯 Backlight small panel lamp



型号 (Model)	BKS-S/BKS-R
功率 (Power)	6W 12W 18W 24W
电源类型 (Type of power supply)	No-isolated
灯珠型号 (Chip model)	2835 12V 2W
发光角度 (Luminous angle)	120°
LED功耗/光通量 (LED power consumption/luminous flux)	80LM/W

无边框面板灯 Borderless panel lamp



型号 (Model)	BL-S/BL-R
功率 (Power)	6W 16W 22W 32W
电源类型 (Type of power supply)	No-isolated Isolated
灯珠型号 (Chip model)	2835 3V 0.2W
发光角度 (Luminous angle)	120°
LED功耗/光通量 (LED power consumption/luminous flux)	100LM/W

DOB面板灯
DOB panel lamp

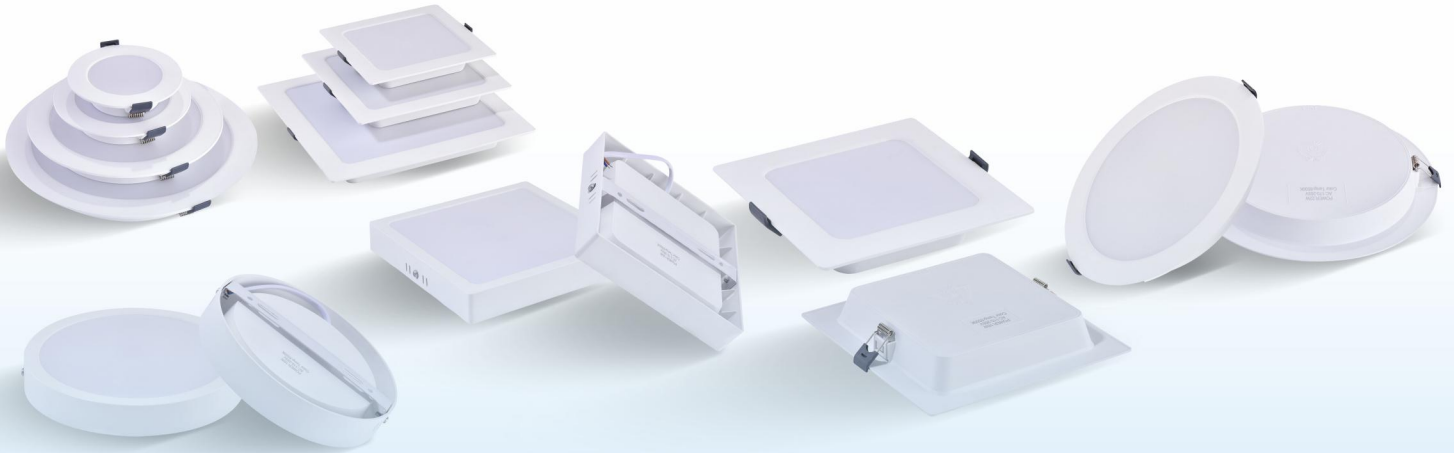

型号 (Model)	DOB-S/DOB-R
功率 (Power)	5W 7W 11W 16W 22W
电源类型 (Type of power supply)	No-isolated
灯珠型号 (Chip model)	2835 3V 0.5W
发光角度 (Luminous angle)	120°
LED功耗/光通量 (LED power consumption/luminous flux)	80LM/W

侧发光面板灯
Side light panel lamp

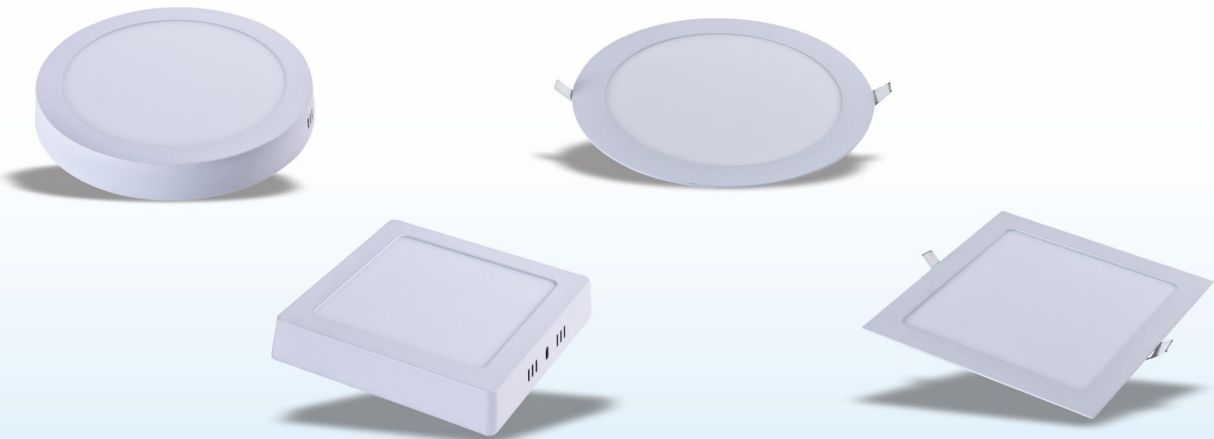

型号 (Model)	SL-S/SL-R
功率 (Power)	3W 6W 9W 12W 15W 18W 24W
电源类型 (Type of power supply)	No-isolated Isolated
灯珠型号 (Chip model)	2835 3V 0.2W
发光角度 (Luminous angle)	120°
LED功耗/光通量 (LED power consumption/luminous flux)	80LM/W

蜂窝面板灯 Honey panel lamp



型号 (Model) : HON-10W/HON-18W

型号 (Model) : HON-24W/HON-36W

超窄边 Ultra-narrow lamp

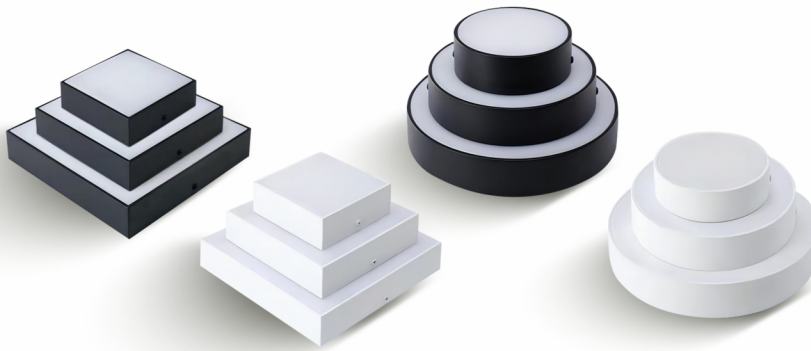

型号 (Model) : UN-18W
型号 (Model) : UN-24W

型号 (Model) : UN-30W
型号 (Model) : UN-48W

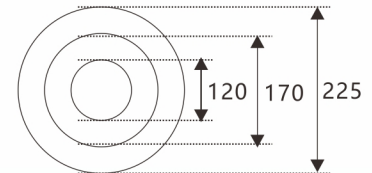
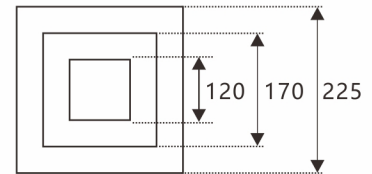

内斜筒灯 Interior inclined downlight

型号 (Model) : ID-9W
型号 (Model) : ID-12W
型号 (Model) : ID-18W
型号 (Model) : ID-25W
型号 (Model) : ID-30W



壁灯
Wall light



型号 (Model) : W1032



型号 (Model) : W1033



型号 (Model) : W1034



型号 (Model) : W1035



IP65 等级防水，无惧风雨
Ip65 waterproof



轨道磁吸灯 Track magnetic absorption lamp



恒星系列 (FX)

型号 (Model)	功率 (Power)	尺寸 (Size)	流明 (Lumen)	色容差 (COLOR TOLERANCE)
FX10	10W	Φ50*145mm	75-90LM/W	≤6
FX20	20W	Φ62*160mm	75-90LM/W	≤6
FX30	30W	Φ75*180mm	75-90LM/W	≤6
FX40	40W	Φ83*180mm	75-90LM/W	≤6

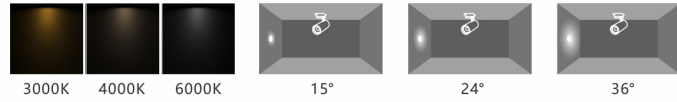

骑飞系列 (FC)

型号 (Model)	功率 (Power)	尺寸 (Size)	流明 (Lumen)	色容差 (COLOR TOLERANCE)
FC20	20W	Φ60*160mm	80-110LM/W	≤6
FC30	30W	Φ70*170mm	80-110LM/W	≤6
FC40	40W	Φ80*180mm	80-110LM/W	≤6
FC50	50W	Φ90*190mm	80-110LM/W	≤6

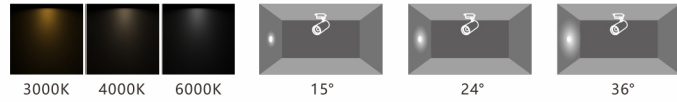

新白富美系列 (FB)

型号 (Model)	功率 (Power)	尺寸 (Size)	流明 (Lumen)	色容差 (COLOR TOLERANCE)
FB10	10W	Φ62*105mm	75-80LM/W	≤6
FB20	20W	Φ75*115mm	75-80LM/W	≤6
FB30	30W	Φ83*125mm	75-80LM/W	≤6

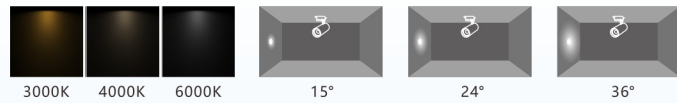

战狼系列 (FW)

型号 (Model)	功率 (Power)	尺寸 (Size)	流明 (Lumen)	色容差 (COLOR TOLERANCE)
FW10	10W	Φ57*120mm	75-90LM/W	≤6
FW20	20W	Φ74*130mm	75-90LM/W	≤6
FW30	30W	Φ85*142mm	75-90LM/W	≤6
FW45	45W	Φ96*165mm	75-90LM/W	≤6

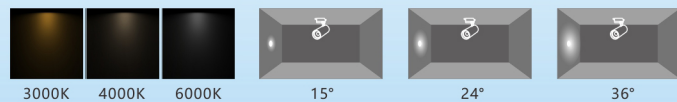

平板灯配件 Panel accessories



吊线盘
(Suspension reel)



吊线包
(Hanger package)



安全绳
(Safety rope)

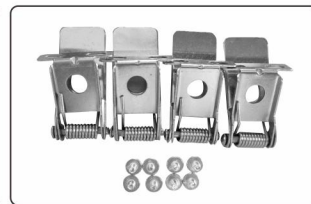

弹簧包
(Spring pack)

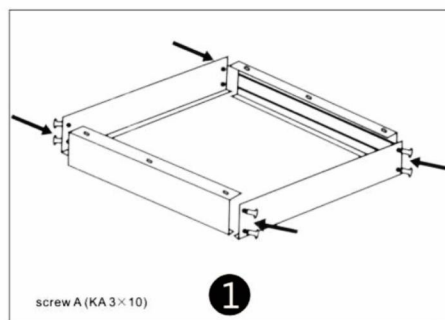
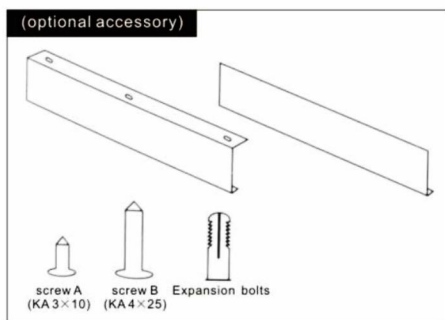
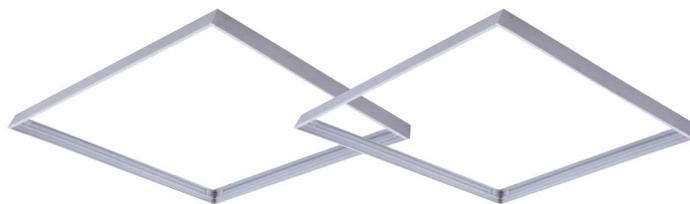
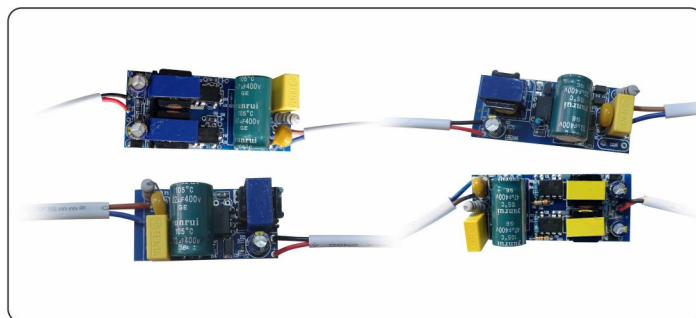
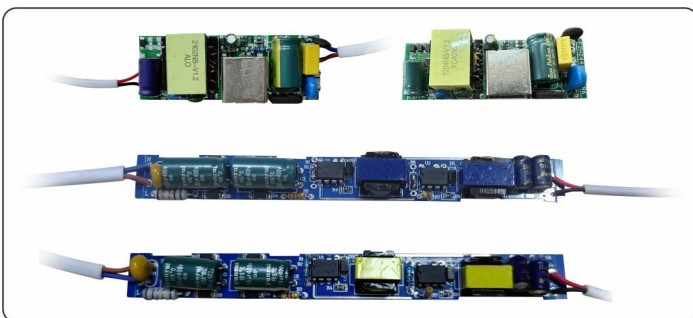

1. Assemble the four frames with Screw A to a whole square.

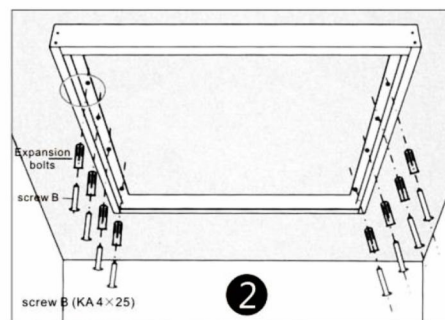

2. Fix the square frames to the ceiling with Screw B.

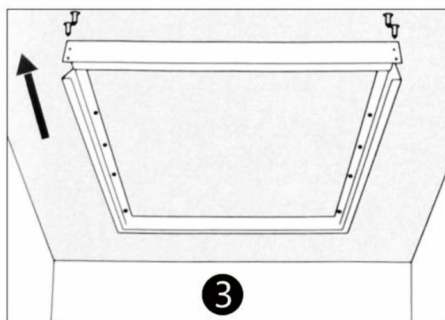

1. Demount one frame.

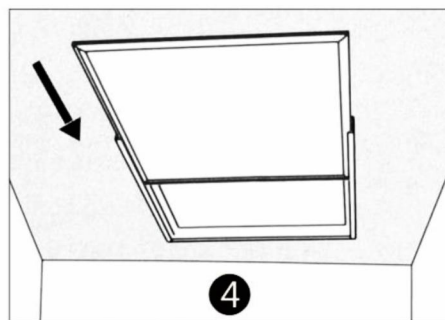

1. Put the panel into frame square.

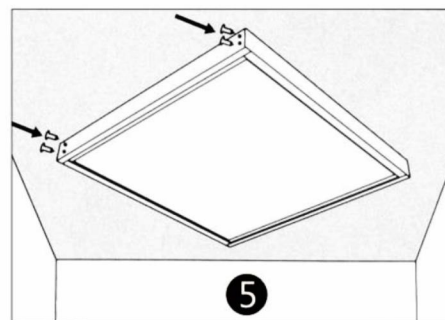

1. Fix the last frame with screw A.



安徽臣昕照明电器有限公司

Anhui Chenxin Lighting Electrical Appliance Co.,LTD

Office address: No.1009, International business center B# block,
Huguang RD, Shushan District, Hefei, China

Tel:+86-551-65856715 Cell:+86-18119606995

Email:cxlight@ahcxlight.com Web:www.ahcxlight.com

<https://ahcxlight.en.made-in-china.com> <https://ahcxlight.en.alibaba.com>